

- 4 cylinders
- 2199 cm³
- 37,5 kW/51,0 HP
- 3000 r.p.m.
- Nm 144,0@2000

Available homologation

- EPA Interim TIER IV ◇
- 2004/26/CE Stage 3A ◇
- ECE R24 ▲

Construction

- 4-stroke diesel engine with cylinders in line
- Fluid-cooled with axial fan.
- Indirect injection.
- Single-shaft distribution with rod, valve levers and hydraulic tappets.
- Geared distribution control.
- Double pto on the crankshaft.
- Two pto on the distribution.
- Counterclockwise, rotation (1° PTO).
- Forced lubrication with vane pump on the crankshaft.
- Total passage external oil filter.
- Positionable fan and water pump.
- Automatic extra fuel starting device.
- Centrifugal governor.
- Torque regulator.
- Cast iron engine block with re-borable integral liners.
- Cast iron cylinder head.

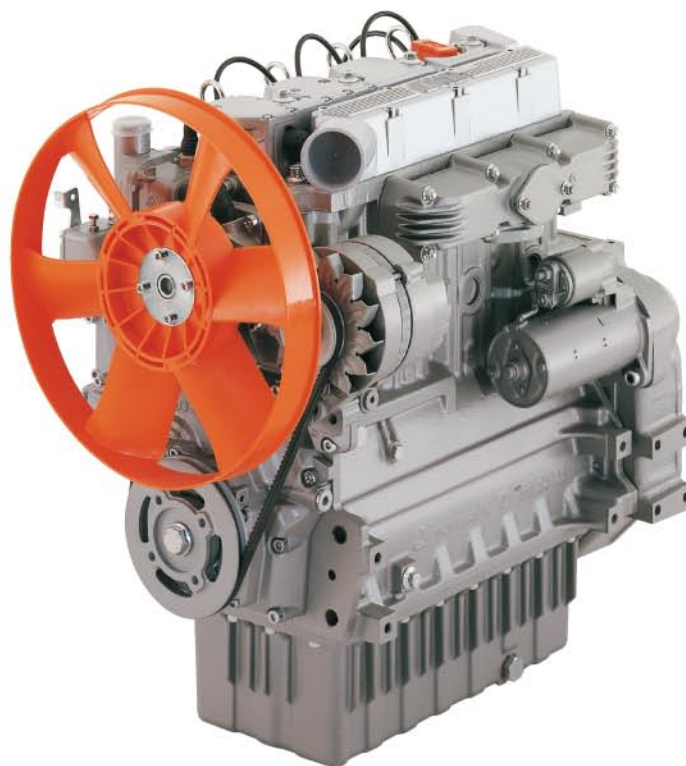

Applications

- Mini excavator
- Excavator
- Fork lift
- Dumper
- Gen set
- Aerial platform
- Compressor
- High pressure cleaner
- Sweeper
- Pump
- Tractor

Specifications

Cylinders	N.	4
Displacement	cm ³	2199
Bore	mm	88
Stroke	mm	90,4
Compression ratio		22,5:1
Rating kW/HP	N (80/1269/CEE) ISO 1585	37,5/51,0
	NB ISO 3046 IFN	34,5/46,9
	NA ISO 3046 ICXN	32,0/44,0
Max. torque	Nm	144,0@2000
Max. torque 3 PT.O.	Nm	39,2@3000
Min. idling speed		900
Water pump delivery at 3000 r.p.m.	l/min.	100
Oil consumption	kg/h.	0,025
Oil sump capacity		
	with dynamic horizontal stabilizer	l 4,5
	without dynamic horizontal stabilizer	l 5,7
Max. allowable inclination for:		
- short periods of operation (max. time 30 minutes)		25°
- peak values (max. time 1 minute)		35°
Cap. of air required for correct combustion @ 3000 r.p.m.	l/min.	3300
Cap. of air required for correct cooling @ 3000 r.p.m.	m ³ /min.	128
Dry weight	kg	192
Recommended battery	V/Ah	12/88

Minimum pulley diameters for belt drive

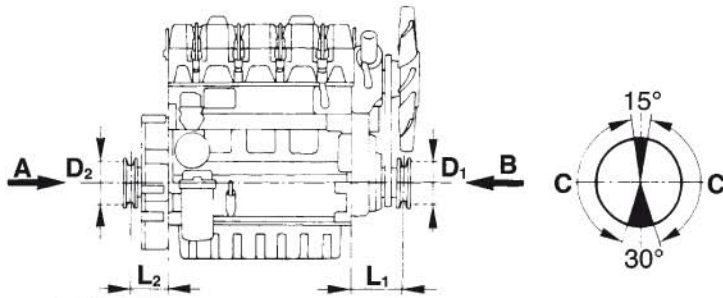

V belt	$D_2 \text{ (mm)} \geq 73 [L_2 \text{ (mm)} + 118]$	$\frac{N \text{ (kW)}}{n \text{ (RPM)}}$
--------	---	--

Cogged belt	$D_1 \text{ (mm)} \geq 46 [L_1 \text{ (mm)} + 118]$	$\frac{N \text{ (kW)}}{n \text{ (RPM)}}$
-------------	---	--

Max. intermittent axial load in both directions A-B = 300 kg
C - zone in which the radial load acts on the pulley

HOMOLOGATIONS EPA Interim TIER IV e 2004/26/CE Stage 3A ◆ ◆

Rating kW @ 3000 rpm	ISO 14396	36,6
Max. torque	Nm	132,5@2100

HOMOLOGATION ECE R24 ▲

Rating kW @ 3000 rpm	ISO 14396	35,0
Max. torque	Nm	130,0@2100

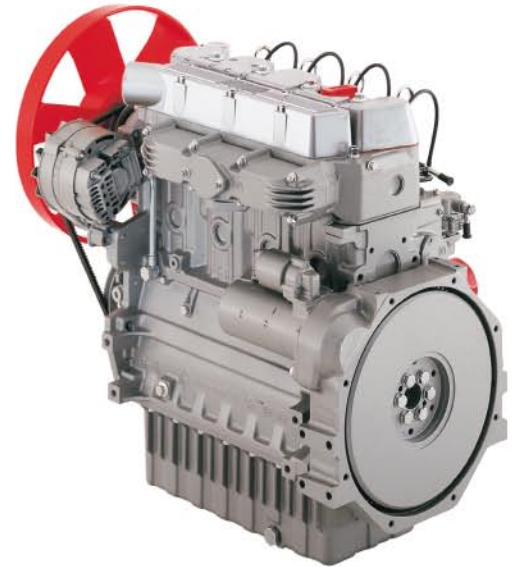

Sound pressure level dB (A)

Sound level polar diagram open field - 7 meters microphone - no load running engine.

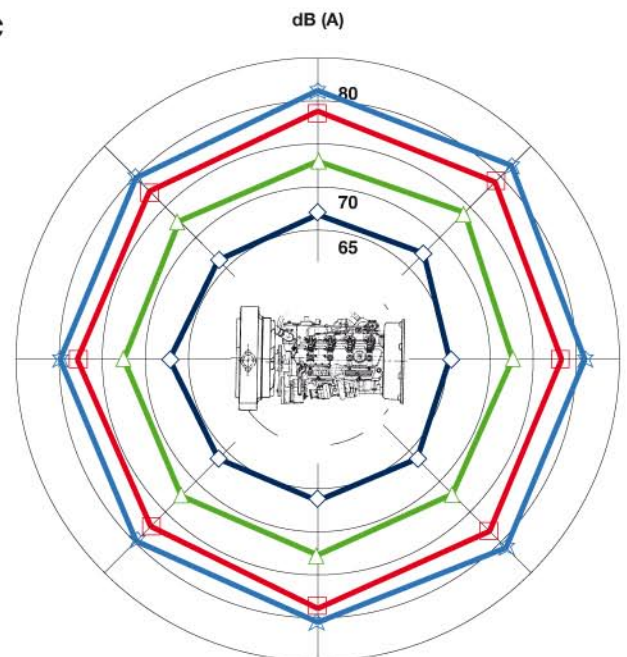

◆ 900 RPM
 ▲ 1800 RPM
 ■ 2500 RPM
 ◆ 3000 RPM

Curves

LDW 2204 @ 3000 r.p.m.

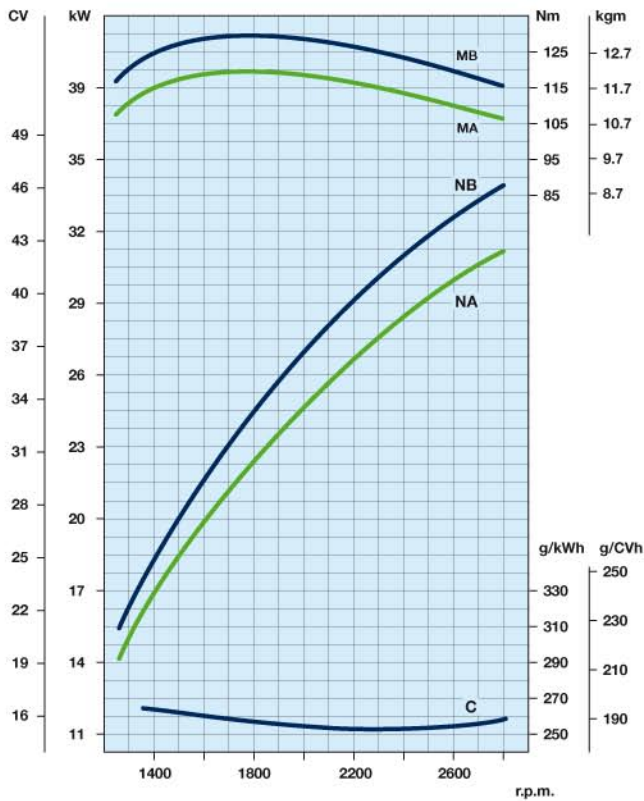

LDW 2204 B1 @ 2800 r.p.m. ▲

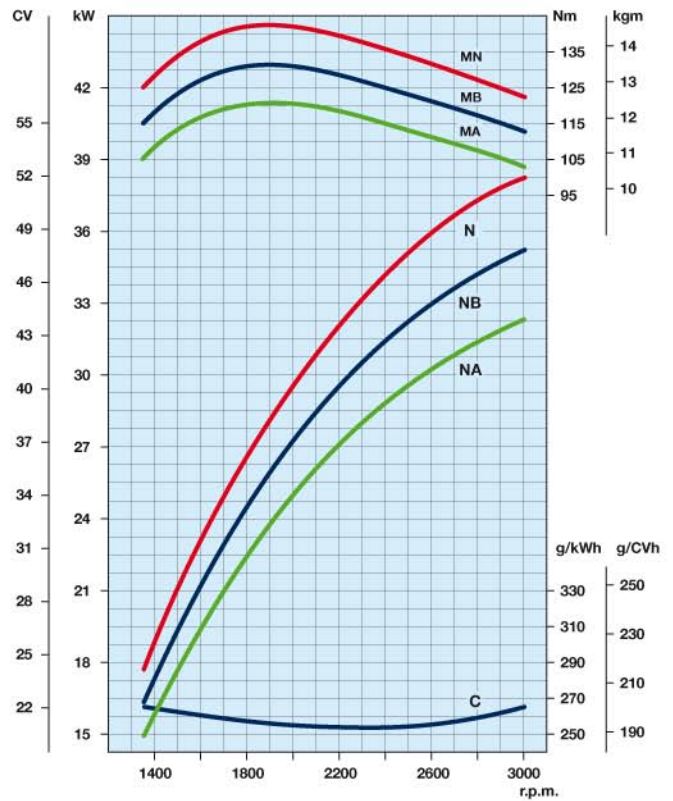

N Power curve - 80/1269/CEE - ISO 1585 -

NB Power curve - ISO 3046 - IFN -

NA Power curve - ISO 3046 - ICXN -

MN Torque curve - (N curve)

MB (NB curve - **MA** (NA curve)

C Specific fuel consumption - (NB curve)

Power ratings refer to engines equipped with air filter, standard muffler, after being run in and in ambient conditions of 20°C and 1 bar. Power levels drop by 1% every 100m altitude and by 2% every 5°C above 20°C.

Output power for fixed speed application (including generating sets)

Engine power kW

r.p.m.	Intermittent (NB)	Continuous (NA)
3000	35,0	31,8
1800	22,5	20,5
1500	19,5	17,7

Technical drawings *

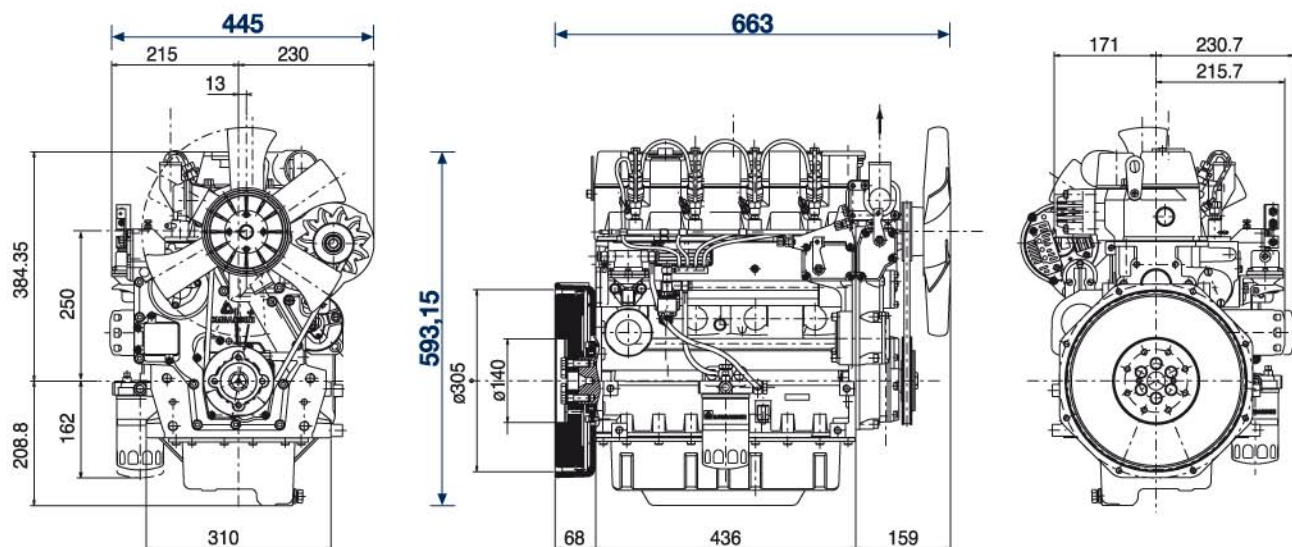

* More specific dimensions are available on www.lombardini.it (see table at the bottom of the page)

Standard equipment

- External oil filter
- Intake manifold
- Exhaust manifold
- Intake fan
- Accelerator control
- Electric starter and 12V alternator
- Thermostatic valve
- Fuel feed diaphragm pump
- Water pump
- Flanging plate
- Flywheel with ring gear
- Use, maintenance and spare parts booklet

Accessories

- Different guards according to use
- Clutches
- Clutch flywheels
- Flanges
- Hydraulic pump adaptors
- Keyswitch panel
- Electric stop
- Electronic plant for plugs
- Alternators
- Radiators
- Blowing fan
- Engine feet
- Fuel tanks
- Mufflers
- Dry air-cleaners mounted and separated
- Cyclonic precleaners
- Fuel filter on engine
- Cab heating system
- High capacity oil sump (see picture)



ISO 9001 Cert. n. 0446 - 1405
QS. 9000 Cert. n. 2231/0



LOMBARDINI
A KOHLER COMPANY

Via Cav. del Lavoro Adelmo Lombardini, 2
42100 Reggio Emilia Italia
Tel. ++39 0522.3891 Fax ++39 0522.389503
www.lombardini.it

Files for this product available on www.lombardini.it

Data sheet	LDW2204DS.PDF
Owner manual	LDW2204OM.PDF
Service manual	LDW2204SM.PDF
Technical drawing	LDW2204TD.DWG
Power curve	LDW2204PC.PDF

LOMBARDINI RESERVES THE RIGHT TO MAKE MODIFICATIONS WITHOUT PRIOR NOTICE

cod. 3558169 - 07-2008